

# Feed Through Terminal Blocks

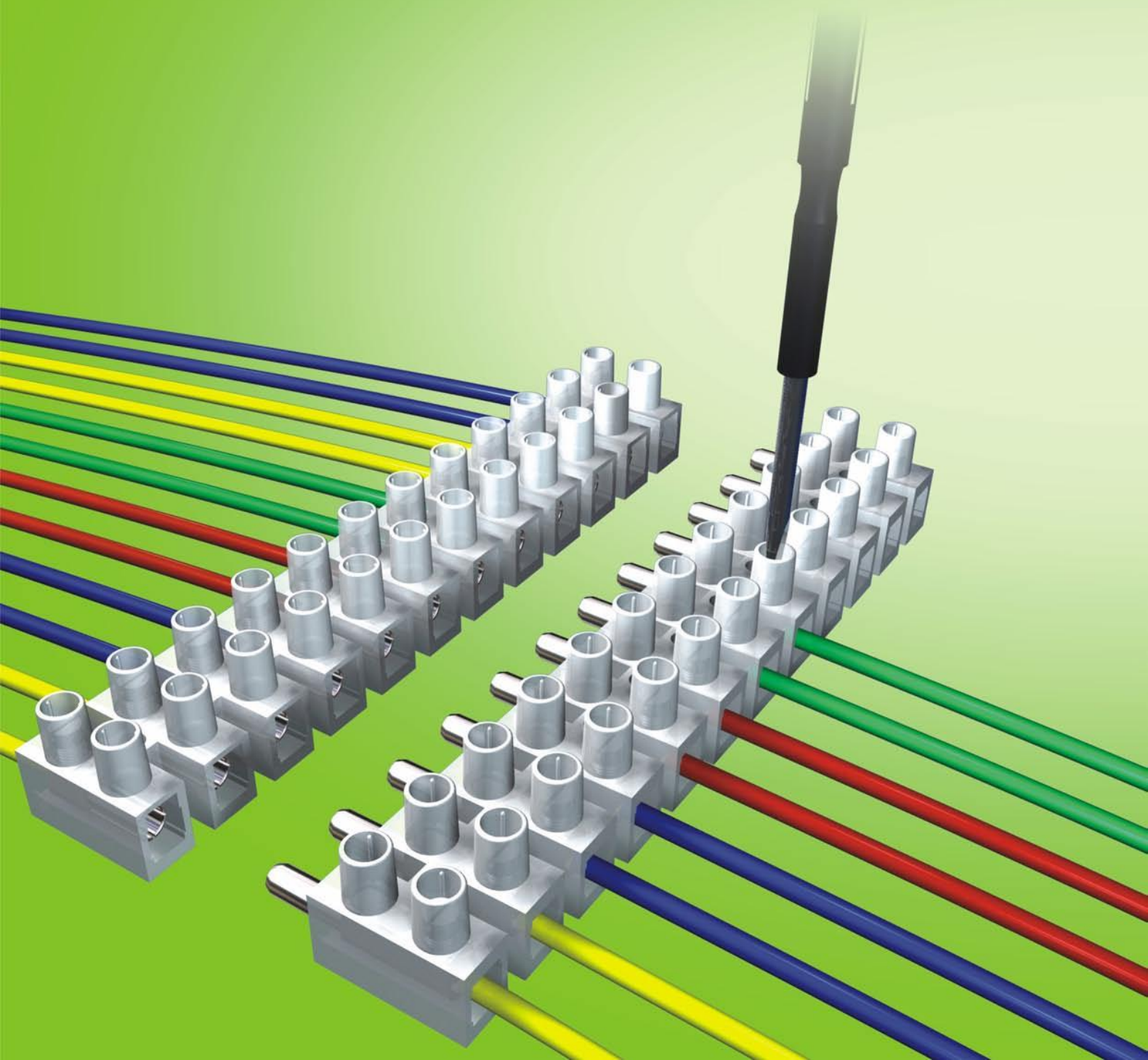

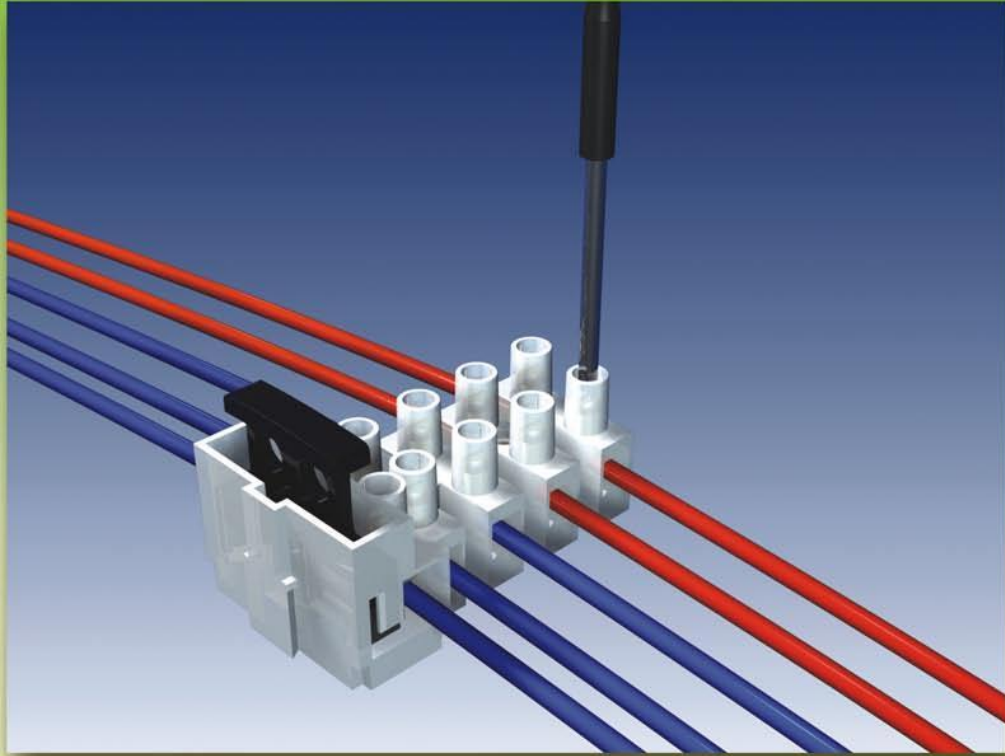

## 贯通式接线端子

Feed through terminal blocks, Connecting with two conductors easily and credibility. provide the wire size from 0.75mm<sup>2</sup> to 30mm<sup>2</sup>. Available for with fuse and without fuse.

The product is designed in accordance with IEC60998, UL1059, CSA 22.2 No. 158 standards and get the approval of UL,VDE,CQC,etc.

贯通式接线端子，将二导体方便、可靠连接起来。可以连接截面为0.75MM<sup>2</sup>至30MM<sup>2</sup>的所有类型的导线。分带保险丝与不带保险丝两种。

产品设计符合IEC60998，UL1059，CSA C22.2 No.158等国际标准，并通过UL VDE CQC等认证。



DG□H-0

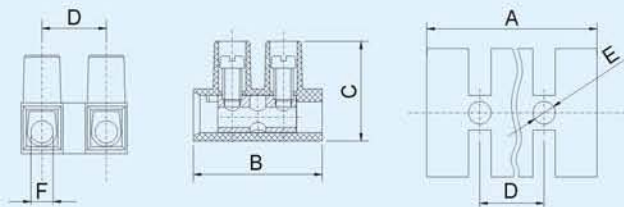

型号 Model	线径 mm <sup>2</sup>	安培 Amp	电压 Volt.	螺丝 Screw	尺寸 Dimensions (mm/in.)						
					Unit	A	B	C	D	E	F
DG8H-0	1.5	17.5A	450V	M2.6X5	(mm)	96.0	17.8	14.3	8.20	3.00	2.80
DG10H-0	2.5	24A	450V	M3.0X6	(mm)	116.5	20.0	15.5	10.00	3.50	3.30
DG12H-0	6.0	41A	750V	M3.5X7	(mm)	140.7	23.80	17.8	12.00	3.90	3.90
DG14H-0	10.0	57A	750V	M4X9	(mm)	158.0	25.60	24.0	13.50	4.40	4.80
DG16H-0	16.0	76A	750V	M4X9	(mm)	169.8	28.00	21.8	14.50	4.20	6.00
DG18H-0	25.0	101A	750V	M5X11	(mm)	194.4	36.90	27.5	16.50	4.20	7.50

型号:DG□H-0

底部: 平底型  
材质: 尼龙66, UL94V-2  
温度: -40°C~+105°C  
接线排数: 2-12排

Model:DG□H-0

Base:Flat-bottom  
Housing material PA66,UL94V-2  
Working temperature:-40°C~+105°C  
Poles available:2-12poles



DG□H-1.2

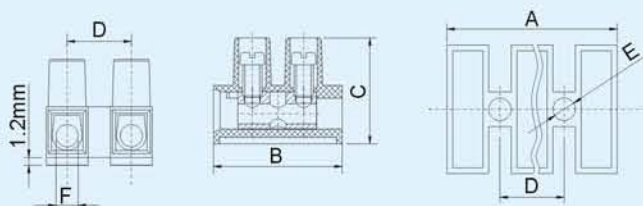

型号 Model	线径 mm <sup>2</sup>	安培 Amp	电压 Volt.	螺丝 Screw	尺寸 Dimensions (mm/in.)						
					Unit	A	B	C	D	E	F
DG8H-1.2	1.5	17.5A	450V	M2.6X5	(mm)	96.0	17.8	15.50	8.20	3.00	2.80
DG10H-1.2	2.5	24A	450V	M3.0X6	(mm)	116.5	20.0	16.70	10.00	3.50	3.30
DG12H-1.2	6.0	41A	750V	M3.5X7	(mm)	140.7	23.80	19.00	12.00	3.90	3.90
DG14H-1.2	10.0	57A	750V	M4X9	(mm)	158.0	25.60	25.20	13.50	4.40	4.80
DG16H-1.2	16.0	76A	750V	M4X9	(mm)	169.8	28.00	23.00	14.50	4.20	6.00
DG18H-1.2	25.0	101A	750V	M5X11	(mm)	194.4	36.90	28.70	16.50	4.20	7.50

型号:DG□H-1.2

底部: H型底部抬高1.2mm  
材质: 尼龙66, UL94V-2  
温度: -40°C~+105°C  
接线排数: 2-12排

Model:DG□H-1.2

Base:With 1.2mm elevated base  
Housing material PA66,UL94V-2  
Working temperature:-40°C~+105°C  
Poles available:2-12poles



DG□H-4.3

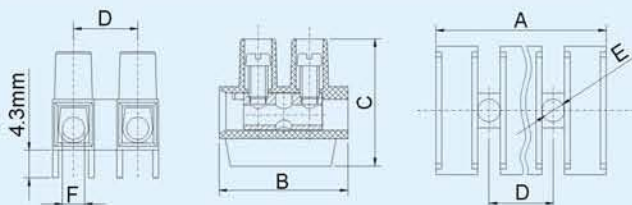

型号 Model	线径 mm <sup>2</sup>	安培 Amp	电压 Volt.	螺丝 Screw	尺寸 Dimensions (mm/in.)						
					Unit	A	B	C	D	E	F
DG8H-4.3	1.5	17.5A	450V	M2.6X5	(mm)	96.0	17.80	18.6	8.20	3.00	2.80
DG10H-4.3	2.5	24A	450V	M3.0X6	(mm)	116.5	20.00	19.8	10.00	3.50	3.30
DG12H-4.3	6.0	41A	750V	M3.5X7	(mm)	140.7	23.80	22.1	12.00	3.90	3.90
DG14H-4.3	10.0	57A	750V	M4X9	(mm)	158.0	25.60	28.3	13.50	4.40	4.80
DG16H-4.3	16.0	76A	750V	M4X9	(mm)	169.8	28.00	26.1	14.50	4.20	6.00
DG18H-4.3	25.0	101A	750V	M5X11	(mm)	194.4	36.90	31.8	16.50	4.20	7.50

型号:DG□H-4.3

底部: H型底部抬高4.3mm  
材质: 尼龙66, UL94V-2  
温度: -40°C~+105°C  
接线排数: 2-12排

Model:DG□H-4.3

Base:With 4.3mm elevated base  
Housing material PA66,UL94V-2  
Working temperature:-40°C~+105°C  
Poles available:2-12poles



DG□HWP-0

带弹片 Wire Protector

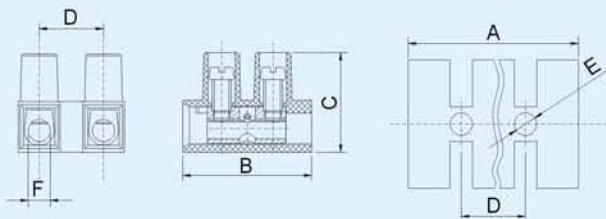

型号 Model	线径 mm <sup>2</sup>	安培 Amp	电压 Volt.	螺丝 Screw	尺寸 Dimensions (mm/in.)						
					Unit	A	B	C	D	E	F
DG8HWP-0	1.5	17.5A	450V	M2.6X5	(mm)	96.0	17.8	14.3	8.20	3.00	2.80
DG10HWP-0	2.5	24A	450V	M3.0X6	(mm)	116.5	20.0	15.5	10.00	3.50	3.30
DG12HWP-0	6.0	41A	750V	M3.5X7	(mm)	140.7	23.80	17.8	12.00	3.90	3.90
DG14HWP-0	10.0	57A	750V	M4X9	(mm)	158.0	25.60	24.0	13.50	4.40	4.80
DG16HWP-0	16.0	76A	750V	M4X9	(mm)	169.8	28.00	21.8	14.50	4.20	6.00
DG18HWP-0	25.0	101A	750V	M5X11	(mm)	194.4	36.90	27.5	16.50	4.20	7.50

带弹片  
Wire Protector

型号: DG□HWP-0  
Model: DG□HWP-0

底部: 平底型  
材质: 尼龙66, UL94V-2  
温度: -40°C~+105°C  
接线排数: 2-12排

Base: Flat-bottom  
Housing material PA66, UL94V-2  
Working temperature: -40°C~+105°C  
Poles available: 2-12poles



DG□HWP-1.2

带弹片 Wire Protector

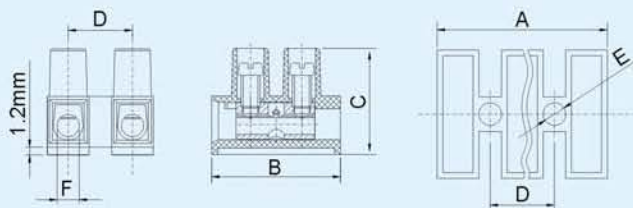

型号 Model	线径 mm <sup>2</sup>	安培 Amp	电压 Volt.	螺丝 Screw	尺寸 Dimensions (mm/in.)						
					Unit	A	B	C	D	E	F
DG8HWP-1.2	1.5	17.5A	450V	M2.6X5	(mm)	96.0	17.8	15.50	8.20	3.00	2.80
DG10HWP-1.2	2.5	24A	450V	M3.0X6	(mm)	116.5	20.0	16.70	10.00	3.50	3.30
DG12HWP-1.2	6.0	41A	750V	M3.5X7	(mm)	140.7	23.80	19.00	12.00	3.90	3.90
DG14HWP-1.2	10.0	57A	750V	M4X9	(mm)	158.0	25.60	25.20	13.50	4.40	4.80
DG16HWP-1.2	16.0	76A	750V	M4X9	(mm)	169.8	28.00	23.00	14.50	4.20	6.00
DG18HWP-1.2	25.0	101A	750V	M5X11	(mm)	194.4	36.90	28.70	16.50	4.20	7.50

带弹片  
Wire Protector

型号: DG□HWP-1.2  
Model: DG□HWP-1.2

底部: H型底部加高1.2mm  
材质: 尼龙66, UL94V-2  
温度: -40°C~+105°C  
接线排数: 2-12排

Base: With 1.2mm elevated base  
Housing material PA66, UL94V-2  
Working temperature: -40°C~+105°C  
Poles available: 2-12poles



DG□HWP-4.3

带弹片 Wire Protector

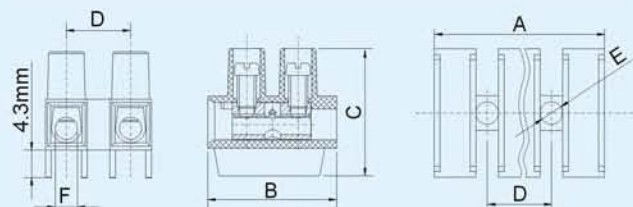

型号 Model	线径 mm <sup>2</sup>	安培 Amp	电压 Volt.	螺丝 Screw	尺寸 Dimensions (mm/in.)						
					Unit	A	B	C	D	E	F
DG8HWP-4.3	1.5	17.5A	450V	M2.6X5	(mm)	96.0	17.80	18.6	8.20	3.00	2.80
DG10HWP-4.3	2.5	24A	450V	M3.0X6	(mm)	116.5	20.00	19.8	10.00	3.50	3.30
DG12HWP-4.3	6.0	41A	750V	M3.5X7	(mm)	140.7	23.80	22.1	12.00	3.90	3.90
DG14HWP-4.3	10.0	57A	750V	M4X9	(mm)	158.0	25.60	28.3	13.50	4.40	4.80
DG16HWP-4.3	16.0	76A	750V	M4X9	(mm)	169.8	28.00	26.1	14.50	4.20	6.00
DG18HWP-4.3	25.0	101A	750V	M5X11	(mm)	194.4	36.90	31.8	16.50	4.20	7.50

带弹片  
Wire Protector

型号: DG□HWP-4.3  
Model: DG□HWP-4.3

底部: H型底部加高4.3mm  
材质: 尼龙66, UL94V-2  
温度: -40°C~+105°C  
接线排数: 2-12排

Base: With 4.3mm elevated base  
Housing material PA66, UL94V-2  
Working temperature: -40°C~+105°C  
Poles available: 2-12poles



Model: DG□HP-0

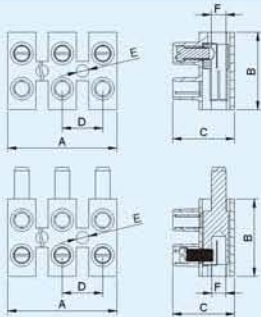

型号 Model	线径 mm <sup>2</sup>	安培 Amp	电压 Volt.	螺丝 Screw	尺寸 Dimensions (mm/in.)						
					Unit	A	B	C	D	E	F
DG8HP-0	1.5	17.5A	450V	M2.6X5	(mm)	96.0	17.8	14.3	8.20	3.00	2.80
DG10HP-0	2.5	24A	450V	M3.0X6	(mm)	116.5	20.0	15.5	10.00	3.50	3.30
DG12HP-0	6.0	41A	750V	M3.5X7	(mm)	140.7	23.80	17.8	12.00	3.90	3.90
DG14HP-0	10.0	57A	750V	M4X9	(mm)	158.0	25.60	24.0	13.50	4.40	4.80
DG16HP-0	16.0	76A	750V	M4X9	(mm)	169.8	28.00	21.8	14.50	4.20	6.00
DG18HP-0	25.0	101A	750V	M5X11	(mm)	194.4	36.90	27.5	16.50	4.20	7.50

型号: DG□HP-0

底部: 平底型  
材质: 尼龙66, UL94V-2  
温度: -40°C~+105°C  
接线排数: 2-12排

Model: DG□HP-0

Base: Flat-bottom  
Housing material PA66, UL94V-2  
Working temperature: -40°C~+105°C  
Poles available: 2-12poles



Model: DG□HP-1.2

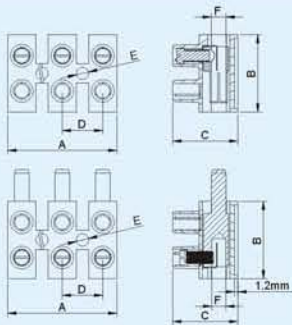

型号 Model	线径 mm <sup>2</sup>	安培 Amp	电压 Volt.	螺丝 Screw	尺寸 Dimensions (mm/in.)						
					Unit	A	B	C	D	E	F
DG8HP-1.2	1.5	17.5A	450V	M2.6X5	(mm)	96.0	17.8	15.50	8.20	3.00	2.80
DG10HP-1.2	2.5	24A	450V	M3.0X6	(mm)	116.5	20.0	16.70	10.00	3.50	3.30
DG12HP-1.2	6.0	41A	750V	M3.5X7	(mm)	140.7	23.80	19.00	12.00	3.90	3.90
DG14HP-1.2	10.0	57A	750V	M4X9	(mm)	158.0	25.60	25.20	13.50	4.40	4.80
DG16HP-1.2	16.0	76A	750V	M4X9	(mm)	169.8	28.00	23.00	14.50	4.20	6.00
DG18HP-1.2	25.0	101A	750V	M5X11	(mm)	194.4	36.90	28.70	16.50	4.20	7.50

型号: DG□HP-1.2

底部: H型底部抬高1.2mm  
材质: 尼龙66, UL94V-2  
温度: -40°C~+105°C  
接线排数: 2-12排

Model: DG□HP-1.2

Base: With 1.2mm elevated base  
Housing material PA66, UL94V-2  
Working temperature: -40°C~+105°C  
Poles available: 2-12poles



Model: DG□HP-4.3

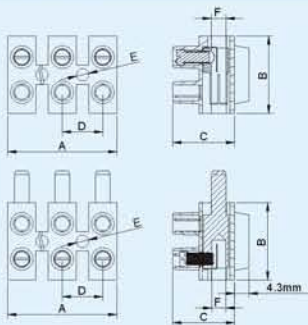

型号 Model	线径 mm <sup>2</sup>	安培 Amp	电压 Volt.	螺丝 Screw	尺寸 Dimensions (mm/in.)						
					Unit	A	B	C	D	E	F
DG8HP-4.3	1.5	17.5A	450V	M2.6X5	(mm)	96.0	17.80	18.6	8.20	3.00	2.80
DG10HP-4.3	2.5	24A	450V	M3.0X6	(mm)	116.5	20.00	19.8	10.00	3.50	3.30
DG12HP-4.3	6.0	41A	750V	M3.5X7	(mm)	140.7	23.80	22.1	12.00	3.90	3.90
DG14HP-4.3	10.0	57A	750V	M4X9	(mm)	158.0	25.60	28.3	13.50	4.40	4.80
DG16HP-4.3	16.0	76A	750V	M4X9	(mm)	169.8	28.00	26.1	14.50	4.20	6.00
DG18HP-4.3	25.0	101A	750V	M5X11	(mm)	194.4	36.90	31.8	16.50	4.20	7.50

型号: DG□HP-4.3

底部: H型底部抬高4.3mm  
材质: 尼龙66, UL94V-2  
温度: -40°C~+105°C  
接线排数: 2-12排

Model: DG□HP-4.3

Base: With 4.3mm elevated base  
Housing material PA66, UL94V-2  
Working temperature: -40°C~+105°C  
Poles available: 2-12poles



**DG252-10.0**

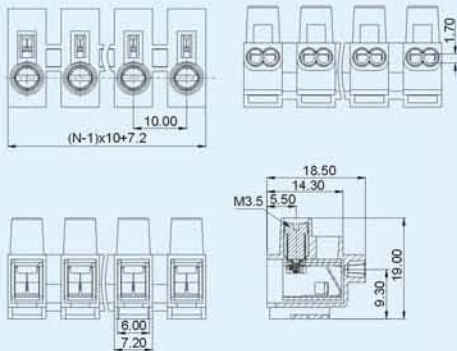

Pitch:10.0mm; Poles:2P~12P

● **Material**

Screws : M3.5 steel Zinc plated  
Wire guard :Stainless steel  
Contact : Steel,Zinc plated  
Housing : PA66, UL94V-0

● **Electrical**

Rated voltage : 400V  
Rated current : 15A  
Contact resistance : 20mΩ  
Insulation resistance : 5000MΩ/DC1000V  
Withstanding voltage: AC2500V/1Min  
Withstanding voltage: 22-16AWG 1.5mm<sup>2</sup>

● **Mechanical**

Temp.Range : -40°C~+105°C  
Torque : 0.8Nm(7.0lb.in)  
Strip length : 7-7.5mm

● **材质及电镀**

螺丝 : M3.5, 钢, 镀锌  
簧片 : 不锈钢  
触点材料: 钢, 镀锌  
塑件 : PA66, UL94V-0

● **电气性能**

额定电压: 400V  
额定电流: 15A  
接触电阻: 20mΩ  
绝缘电阻: 5000MΩ/DC1000V  
耐电压 : AC2500V/1Min  
使用线径: 22-16AWG 1.5mm<sup>2</sup>

● **机械性能**

温度范围: -40°C~+105°C  
扭矩 : 0.8Nm(7.0lb.in)  
剥线长度: 7-7.5mm



**DG1.5V DG2.5V  
DG4V DG6V DG10V  
DG16V DG25V DG35V**

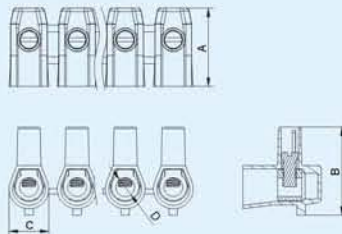

Poles:2P~12P

型号 Model	线径 mm <sup>2</sup>	安培 Amp	电压 Volt.	螺丝 Screw	尺寸 Dimensions (mm/in.)			
					Unit	A	B	C
DG1.5V	1.5	17.5A	450V	M2.5	(mm) 15.0	16.0	7.0	3.3
DG2.5V	2.5	24A	450V	M3.0	(mm) 20.0	18.0	7.5	4.0
DG4V	4.0	32A	450V	M3.5	(mm) 22.0	19.0	9.0	4.5
DG6V	6.0	41A	450V	M4.0	(mm) 25.0	22.0	10.0	6.0
DG10V	10.0	57A	500V	M4.0	(mm) 29.0	25.0	12.0	7.7
DG16V	16.0	76A	500V	M4.5	(mm) 35.0	31.0	16.5	9.5
DG25V	25.0	101A	500V	M5.5	(mm) 38.0	40.0	20.0	12.0
DG35V	35.0	125A	500V	M6.0	(mm) 46.0	43.0	21.0	14.0

Housing material : PC,UL94V-2

Working temperature: 85°C

Poles available : 2-12poles

材质: PC, UL94V-2

温度: 85°C

接线排数: 2-12排



**DG801**

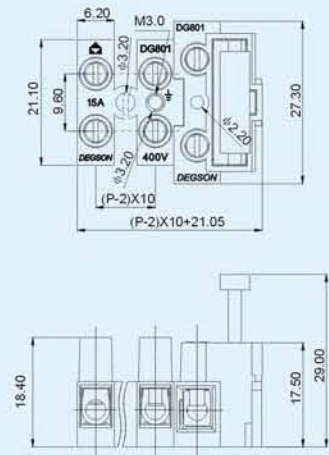

Poles:1P,2P,3P,4P,5P

● **Material**

Screws : M3 steel Zinc plated  
Contact : Brass,Ni plated  
Housing : PA66, UL94V-0

● **Electrical**

Rated voltage : 250V  
Rated current : 10A  
Contact resistance : 20mΩ  
Insulation resistance: 5000MΩ/DC1000V  
Withstanding voltage: AC2000V/1Min  
Wire range : 22-14AWG 2.5mm<sup>2</sup>

● **Mechanical**

Temp.Range : -40°C~+105°C  
MAX Soldering : +250°C,for 5 Sec.  
Torque : 0.5Nm(4.5lb.in)  
Strip length : 6-7mm

● **材质及电镀**

螺丝 : M3, 钢, 镀锌  
触点材料: 黄铜, 镀镍  
塑件 : PA66, UL94V-0

● **电气性能**

额定电压: 250V  
额定电流: 10A  
接触电阻: 20mΩ  
绝缘电阻: 5000MΩ/DC1000V  
耐电压 : AC2000V/1Min  
使用线径: 22-14AWG 2.5mm<sup>2</sup>

● **机械性能**

温度范围: -40°C~+105°C  
瞬时温度: +250°C 5秒  
扭矩 : 0.5Nm(4.5lb.in)  
剥线长度: 6-7mm